

KOMATSU®

PC300-8M0 PC300LC-8M0 PC350LC-8M0

Australian - NZ Specification

ecot3

HORSEPOWER

Gross: 194 kW 260 HP / 1950 min⁻¹

Net: 187 kW 250 HP / 1950 min⁻¹

OPERATING WEIGHT

PC300-8M0: 33400–33900kg

PC300LC-8M0: 34200–34700kg

PC350LC-8M0: 35800–36600kg

PC
300 350



Photos may include optional equipment.

HYDRAULIC EXCAVATOR

WALK-AROUND

Productivity Features

• High Production and Low Fuel Consumption

High power, working performance and fuel efficiency improve production and fuel costs

• Large Drawbar Pull

Provides superb steering and slope climbing performance.

• Large Digging Force

Pressing the Power Max function button temporarily increases the digging force 7%

• Two-mode Setting for Boom

Switch selection allows either powerful digging or smooth boom operation

See pages 4 and 5

Ecology and Economy Features

• A powerful turbocharged and air to air aftercooled Komatsu SAA6D114E-3 engine provides **187 kW** 250 HP. This engine is EPA Tier 3 and EU Stage 3A emissions equivalent, without sacrificing power or machine productivity

• Economy mode saves fuel consumption

• Low operation noise

See pages 4 and 5

Large Comfortable Cab

• Low-noise cab

• Low vibration with cab damper mounting

• Highly pressurized cab

• Operator seat and console with armrest that enables operations in the appropriate operational posture

See page 6

Safety Design

• ROPS cab (ISO 12117-2) for protecting the operator in the event of a roll-over

• Slip-resistant plates for improved foot grip

• Rear view monitoring system for viewing the work area to the rear of the machine

See page 7

Information & Communication Technology

• Large multi-lingual high resolution LCD monitor

• Supports efficiency improvement

• Equipped with the EMMS monitoring system

See page 8

Easy Maintenance

• Long replacement interval of engine oil, engine oil filter, hydraulic oil and hydraulic filter.

• Equipped with fuel pre-filter as standard (with water separator)

• Side-by-side radiator and oil cooler configuration enables independent removal and installation of those two components.

• Equipped with the EMMS monitoring system

• Easy access to engine oil filter and fuel drain valve

• Large fuel tank capacity

See page 9

Komatsu Australia Ltd Standard Specification (KALSS)

• Unique specification developed specifically for the Australian and New Zealand market

• Factory designed and fitted to support local requirements and reduce delivery lead times

• Enables compliance to local legislation and site safety standards

See page 10



Photo may include optional equipment

PRODUCTIVITY & ECOLOGY FEATURES

Komatsu Technology



Komatsu develops and produces all major components, such as engines, electronics and hydraulic components, in house. With this "Komatsu Technology," and adding customer feedback, Komatsu is achieving great advancements in technology. To achieve both high levels of productivity and economical performance, Komatsu has developed the main components with a total control system. The result is a new generation of high performance and environment-friendly excavators.

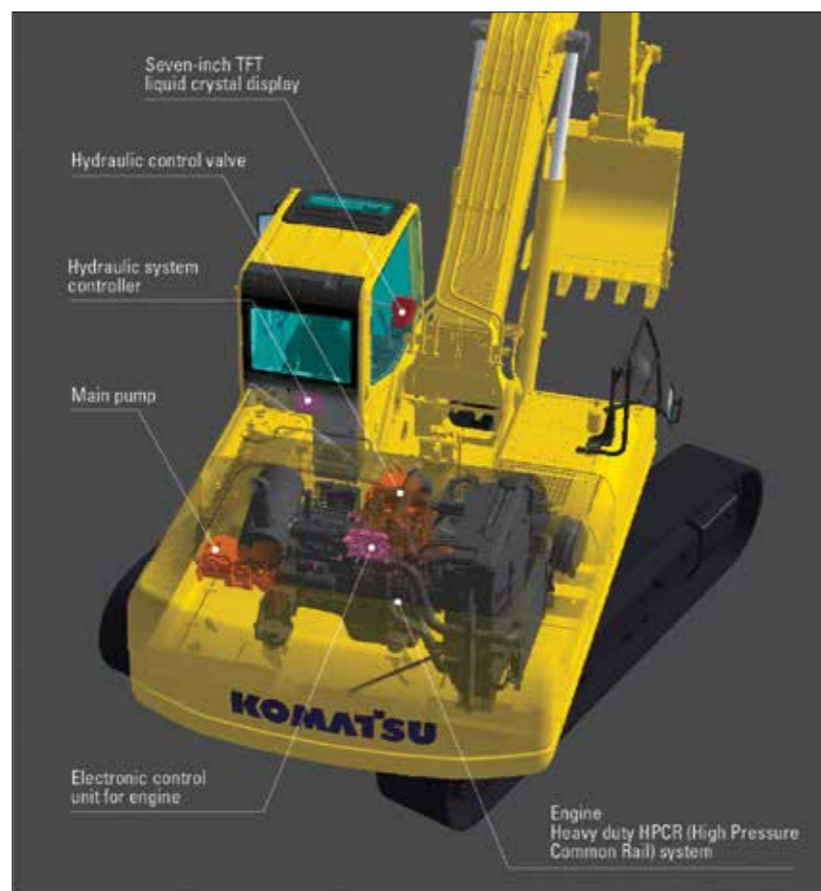

Low Emission Engine

Komatsu SAA6D114E-3 reduced NOx emission by 33% compared with the PC300-7. This engine is EPA Tier 3 and EU Stage 3A emissions equivalent.



Low Operation Noise

Enables a low noise operation using the low-noise engine and methods to cut noise at source.

Low Fuel Consumption

The newly-developed Komatsu SAA6D114E-3 engine enables NOx emissions to be significantly reduced with the accurate multi-staged fuel injection by the engine controller. It improves total engine durability using the high-pressure fuel injection system developed specifically for construction machinery. This excavator significantly reduces hourly fuel consumption using the highly-efficient matching techniques of the engine and hydraulic unit and also provides features that promote energy-saving operations such as the E mode and ECO-gauge.

Fuel consumption **3% reduced**

vs. PC300/LC-8 & PC350LC-8
Based on typical work pattern collected via KOMTRAX.
Fuel consumption varies depending on job conditions.

Idling Caution

To prevent unnecessary fuel consumption, an idling caution is displayed on the monitor, if the engine idles for 5 minutes or more.



Working Modes Selectable

This excavator is equipped with six working modes (P, E, L, B, ATT/P and ATT/E mode). Each mode is designed to match engine speed and pump output to the application. This provides the flexibility to match equipment performance to the job at hand.



Working Mode	Application	Advantage
P	Power mode	<ul style="list-style-type: none"> Maximum production/power Fast cycle times
E	Economy mode	<ul style="list-style-type: none"> Good cycle times Better fuel economy
L	Lifting mode	<ul style="list-style-type: none"> Suitable attachment speed Lifting capacity is increased 7% by raising hydraulic pressure.
B	Breaker mode	<ul style="list-style-type: none"> Optimum engine rpm, hydraulic flow
ATT/P	Attachment Power mode	<ul style="list-style-type: none"> Optimum engine rpm, hydraulic flow, 2way Power mode
ATT/E	Attachment Economy mode	<ul style="list-style-type: none"> Optimum engine rpm, hydraulic flow, 2way Economy mode

ECO-gauge that Assists Energy-saving Operations

Equipped with the ECO-gauge that can be recognized at a glance on the right of the multi-function color monitor for environment-friendly energy-saving operations. Allows focus on operation in the green range with reduced CO₂ emissions and efficient fuel consumption.



ECO-gauge

Larger Maximum Drawbar Pull

Larger maximum drawbar pull provides superb steering and slope climbing performance.
Maximum drawbar pull:
264 kN 26900 kg



Large Digging Force

With the one-touch Power Max. function digging force has been further increased. (8.5 seconds of operation)

Maximum arm crowd force (ISO):
160 kN (16.3t) → **171 kN (17.4t)** (with Power Max.) 7% UP

Maximum bucket digging force (ISO):
213 kN (21.7t) → **228 kN (23.2t)** (with Power Max.) 7% UP

*Measured with Power Max function, 3185 mm arm and ISO rating

Smooth Loading Operation

Two return hoses improve hydraulic performance. In the arm out function, a portion of the oil is returned directly to the tank providing smooth operation.

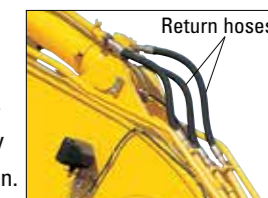

Two-mode Setting for Boom

Smooth mode provides easy operation for gathering blasted rock or scraping down operation. When maximum digging force is needed, switch to Power mode for more effective excavating.

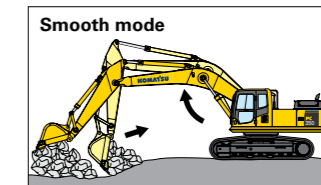

Boom floats upward, reducing lifting of machine front. This facilitates gathering blasted rock and scraping down operations.

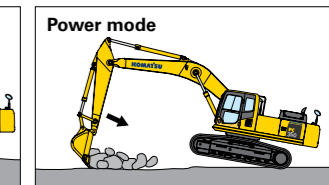

Boom pushing force is increased, ditch digging and box digging operation on hard ground are improved.

WORKING ENVIRONMENT



Low Cab Noise

The newly-designed cab is highly rigid and has excellent sound absorption ability. Thorough improvement of noise source reduction and use of low noise engine, hydraulic equipment, and air conditioner allows this machine to generate a low level of noise.

Low Vibration with Cab Damper Mounting

PC300/LC-8M0 & PC350LC-8M0 uses viscous damper mounting for cab that incorporates longer stroke and the addition of a spring. The new cab damper mounting combined with high rigidity deck aids vibration reduction at operator seat.

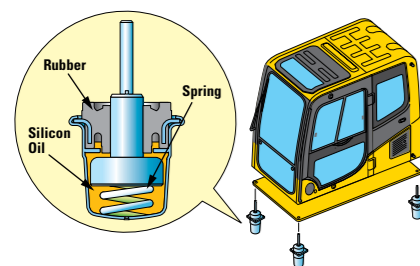

Wide Newly-designed Cab

Newly-designed wide spacious cab includes seat with reclining backrest. The seat height and longitudinal inclination are easily adjusted using a pull-up lever. You can set the appropriate operational posture of armrest together with the console.

Reclining the seat further enables you to place it into the fully flat state with the headrest attached.



Pressurized Cab

Optional air conditioner, air filter and a higher internal air pressure (+6.0 mm Aq) prevent external dust from entering the cab.

Automatic Air Conditioner

Enables you to easily and precisely set cab atmosphere with the instruments on the large LCD. The bi-level control function keeps the operator's head and feet cool and warm respectively. This improved air flow function keeps the inside of the cab comfortable throughout the year. Defroster function keeps front glass clear.

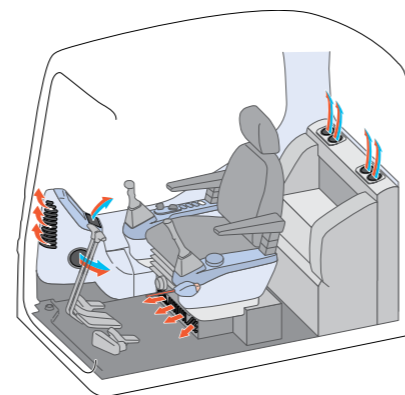

Safety Features

ROPS Cab

The machine is equipped with a ROPS cab that conforms to ISO 12117-2 for excavators as standard equipment. The ROPS cab has high shock-absorption performance, featuring excellent durability and impact strength. It also satisfies the requirements of ISO OPG top guard level 1 for falling objects. Combined with the retractable seat belt, The ROPS cab protects the operator in case of tipping over and against falling objects.

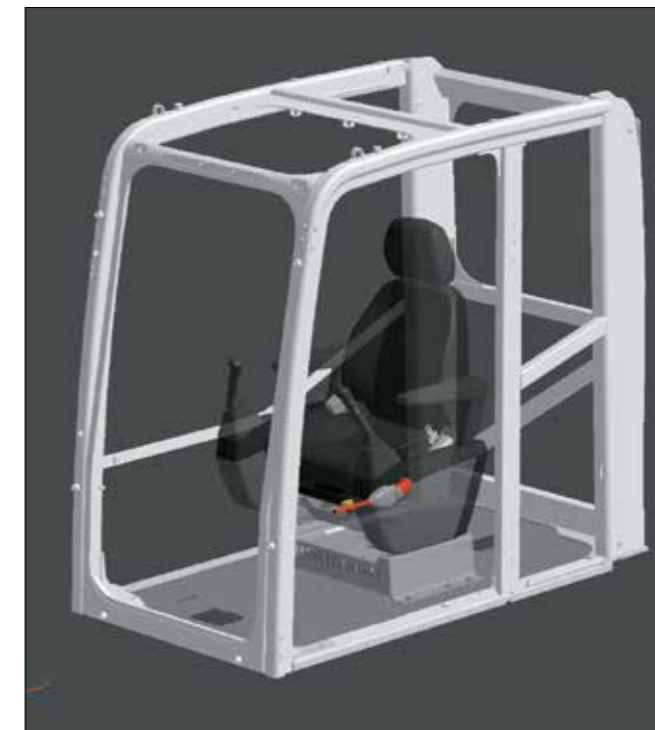

Lock Lever

Locks the hydraulic pressure to prevent unintentional movement. Neutral start function allows machine to be started only in lock position.



Large Side-view, and Sidewise Mirrors

Enlarged left-side mirror and addition of sidewise allow the PC300/LC-8M0 & PC350LC-8M0 to meet the new ISO visibility requirements.



Rear View Monitoring System

The operator can view the rear of the machine with a color monitor screen.



Rear view image on monitor

Thermal and Fan Guards

Thermal and fan guards are placed around high-temperature parts of the engine and fan drive.



Slip-resistant Plates

Highly durable slip-resistant plates maintain superior traction performance for the long term.



Pump/engine Room Partition

Pump/engine room partition prevents oil from spraying onto the engine if a hydraulic hose should burst.

INFORMATION & COMMUNICATION TECHNOLOGY



Large Multi-lingual High Resolution LCD Monitor

A large user-friendly high resolution LCD color monitor enables safe, accurate and smooth work. Visibility and resolution are further improved compared with current 7-inch large TFT LCD.

Simple and easy to operate switches. Function keys facilitate multi-function operations.

Displays data in 13 languages to globally support operators around the world.

TFT : Thin Film Transistor
LCD : Liquid Crystal Display

Indicators

- | | |
|----------------------------------|-----------------------------------|
| 1 Auto-decelerator | 5 Hydraulic oil temperature gauge |
| 2 Working mode | 6 Fuel gauge |
| 3 Travel speed | 7 ECO-gauge |
| 4 Engine water temperature gauge | 8 Fuel consumption gauge |
| | 9 Function switches menu |

Basic operation switches

- | | |
|-------------------------|---------------------|
| 1 Auto-decelerator | 4 Buzzer cancel |
| 2 Working mode selector | 5 Wiper |
| 3 Traveling selector | 6 Windshield washer |

Supports Efficiency Improvement

The main screen displays advices for promoting energy-saving operations as needed. The operator can use the ECO Guidance menu to check the Operation Records, ECO Guidance Records, Average Fuel Consumption Logs, etc.



ECO guidance

ECO guidance menu



ECO guidance records

Operation records

Average fuel consumption logs

Equipment Management Monitoring System (EMMS) Monitor Function

Controller monitors engine oil level, coolant temperature, battery charge air clogging, etc. If the controller finds any abnormality, it is displayed on the LCD.



Maintenance Function

The monitor informs replacement time of oil and filters on the LCD when the replacement interval is reached.



Trouble Data Memory Function

Monitor stores abnormalities for effective troubleshooting.

MAINTENANCE FEATURES

Easy Radiator Cleaning

Since radiator and oil cooler are arranged side-by-side, it is easy to clean, remove and install them.



Equipped with the Eco-drain Valve as Standard

Prevents clothes and the ground from becoming contaminated due to oil leakage when replacing the engine oil.

Easy Access to Engine Oil Filter and Fuel Drain Valve

Engine oil level gauge, and fuel filter are one side mounted to improve accessibility. Engine oil filter and fuel drain valve are remotely mounted to improve accessibility.



Engine Oil Filter



Fuel Drain Valve

Equipped with the Fuel Pre-filter (with Water Separator)

Removes water and contaminants in the fuel to prevent fuel problems.



Long-life Oil, Filter

Uses high-performance filtering materials and long-life oil. Extends the oil and filter replacement interval.

- Engine oil & Engine oil filter every **500** hours
Hydraulic oil every **5000** hours
Hydraulic oil filter every **1000** hours

Large Fuel Tank Capacity

Large fuel tank capacity extends operating hours before refueling. Fuel tank is treated for rust prevention.

High-capacity Air Cleaner

High capacity air cleaner is comparable to that of larger machines. The larger air cleaner can extend air cleaner life during long-term operation and prevents early clogging and resulting power decrease.

Reliability is improved by a new seal design.



Photo may include optional equipment

KALSS Australian Standard Specification

**Level Indicator
Overload Alarm
Boom and Arm Anti-Burst Valves**
Enable compliance when lifting suspended loads.



**Additional Mirrors
and Lighting**
For improved visibility and illumination



**OPG Level 2 Top Guard
(ISO 10262)**
For falling object protection.

Rotating Amber Beacon
Fitted with factory guard.



Rock Guard
Reinforced steel plate and ribs to provide additional protection of arm structure.



Heavy-Duty Boom and Arm
With continuous plates and cast tips to provide increased durability and reliability.

High Capacity Air Conditioner
With increased cool down performance.

Factory Fitted Handrails
To improve machine access and reduce fall hazards.

Track Frame and Revolving Frame Under Cover
Prevents ingress of material into slew ring area and engine bay.

Photo may include optional equipment

Factory Fitted Quick Hitch and Hammer Piping
Enable use with a greater variety of attachments.

Lower Windscreen Guard
Protects cabin windscreen against rocks and debris.



E-Stops
Allow compliance to site safety requirements with standard factory wiring for trouble free operation.



Battery Isolation
Single pole, lockable Bosch-type battery isolation.



Bump Rails
For upper structure protection when slewing.



Heavy Duty Wide Undercarriage Design PC350LC-8M0 Only

- Extra heavy duty track frame provides durability in heavy construction and quarry conditions as well as low centre of gravity and wider track gauge for greater stability.
- Full length track roller guards provide complete protection of track rollers against rock and debris damage.
- Lift capacity is increased by 12% over the PC300LC-8M0.
- Centre frame ground clearance is increased to 644mm.
- Gauge width increased to 3310mm.



Specification also includes factory fitted provisions for fire extinguishers, turbo timer, UHF and vandal covers to enable ease and reduce cost of local fitment.

ENGINE

Model Komatsu SAA6D114E-3
Type Water-cooled, 4-cycle, direct injection
Aspiration Turbocharged, aftercooled
Number of cylinders 6
Bore 114 mm
Stroke 135 mm
Piston displacement 8.27 L
Horsepower:
SAE J1995 Gross 194 kW 260 HP
ISO 9249 / SAE J1349 Net 187 kW 250 HP
Rated rpm 1950 min⁻¹
Fan drive method for radiator cooling Mechanical Governor
All-speed control, electronic

EPA Tier 3 and EU Stage 3A emissions equivalent.

HYDRAULICS

Type HydraMind (Hydraulic Mechanical Intelligence New Design) system, closed-centre system with load sensing valves and pressure compensated valves
Number of selectable working modes 6
Main pump:
Type Two variable displacement piston type
Pumps for Boom, arm, bucket, swing, and travel circuits
Maximum flow 535 L / min
Supply for control circuit Self-reducing valve
Hydraulic motors:
Travel 2 x axial piston motor with parking brake
Swing 1 x axial piston motor with swing holding brake
Relief valve setting:
Implement circuits 37.3 MPa 380 kg/cm²
Travel circuit 37.3 MPa 380 kg/cm²
Swing circuit 27.9 MPa 285 kg/cm²
Pilot circuit 3.2 MPa 33 kg/cm²
Hydraulic cylinders:
(Number of cylinders – bore x stroke x rod diameter)
Boom 2–140 mm x 1480 mm x 100 mm
Arm 1–160 mm x 1825 mm x 110 mm
Bucket for 3.185 m & 4.02 m arm 1–140 mm x 1285 mm x 100 mm
Bucket for 2.55 m arm 1–150 mm x 1285 mm x 110 mm

DRIVES AND BRAKES

Steering control Two levers with pedals
Drive method Hydrostatic
Maximum drawbar pull 264 kN 26900 kg
Gradeability 70%, 35°
Maximum travel speed: High 5.5 km/h (Auto-Shift)
Mid 4.5 km/h (Auto-Shift)
Low 3.2 km/h
Service brake Hydraulic lock
Parking brake Mechanical disc brake

SWING SYSTEM

Drive method Hydrostatic
Swing reduction Planetary gear
Swing circle lubrication Grease-bathed
Service brake Hydraulic lock
Holding brake/Swing lock Mechanical disc brake
Swing speed 9.5 min⁻¹

UNDERCARRIAGE

Center frame X-frame
Track frame Box-section
Seal of track Sealed track
Track adjuster Hydraulic
Number of shoes (each side):
PC300-8M0 45
PC300LC-8M0 / PC350LC-8M0 48
Number of carrier rollers 2 each side
Number of track rollers (each side):
PC300-8M0 7
PC300LC-8M0 / PC350LC-8M0 8

COOLANT AND LUBRICANT CAPACITY (REFILLING)

Fuel tank 605 L
Coolant 31.0 L
Engine 37.0 L
Final drive, each side 9.0 L
Swing drive 16.5 L
Hydraulic tank 188 L

OPERATING WEIGHT (APPROXIMATE)

Operating weight including 6470 mm one-piece boom, 3185 mm arm, 600 mm shoes, rated capacity of lubricants, coolant, full fuel tank, operator, standard equipment, KGA quick hitch and 1500mm KGA bucket (PC300-8M0, PC300LC-M0) or 1700 mm KGA bucket (PC350LC-8M0).

PC300-8M0		PC300LC-8M0		PC350LC-8M0	
Operating Weight	Ground Pressure	Operating Weight	Ground Pressure	Operating Weight	Ground Pressure
33800 kg	0.7kg/cm ²	34600 kg	0.66 kg/cm ²	36300 kg	0.69 kg/cm ²

RATED CAPACITY

Rated capacity when fitted with 6470 mm boom, 3185 mm arm, 600 mm shoes and lifting suspended loads with KGA quick hitch (as per Australian standards).

PC300-8M0 3150 kg
PC300LC-8M0 3200 kg
PC350LC-8M0 3650 kg

 DIMENSIONS

Arm Length		3185 mm		
	Model	PC300-8M0	PC300LC-8M0	PC350LC-8M0
A	Overall length	11150 mm	11150 mm	11140 mm
B	Length on ground	5755 mm	5930 mm	5930 mm
C	Overall height (to top of boom)*	3285 mm	3285 mm	3285 mm
D	Overall width	3190 mm	3190 mm	3310 mm
E	Overall height (to top of cab)*	3145 mm	3145 mm	3190 mm
F	Ground clearance, counterweight	1185 mm	1185 mm	1230 mm
G	Ground clearance (minimum)	500 mm	500 mm	644 mm
H	Tail swing radius	3450 mm	3450 mm	3450 mm
I	Track length on ground	3700 mm	4030 mm	4030 mm
J	Track length	4625 mm	4955 mm	4955 mm
K	Track gauge	2590 mm	2590 mm	2710 mm
L	Width of crawler	3190 mm	3190 mm	3310 mm
M	Shoe width	600 mm	600 mm	600 mm
N	Grouser height	36 mm	36 mm	36 mm
O	Machine cab height	2585 mm	2585 mm	2630 mm
P	Machine cab width **	3090 mm	3090 mm	3090 mm
Q	Distance, swing centre to rear end	3405 mm	3405 mm	3405 mm

*: Including grouser height
**: Including handrail

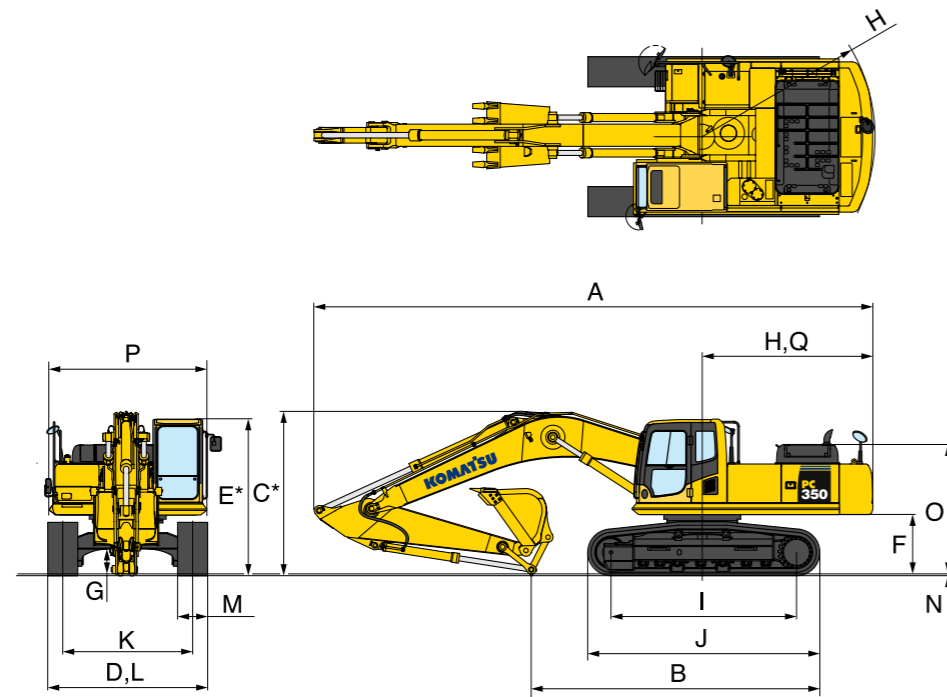

 WORKING RANGE

	Model	PC300/LC-8M0	PC350LC-8M0
A	Max. digging height	10100 mm	10100 mm
B	Max. dumping height	7050 mm	7050 mm
C	Max. digging depth	7380 mm	7380 mm
D	Max. vertical wall digging depth	6400 mm	6400 mm
E	Max. digging depth of cut for 8' level	7180 mm	7180 mm
F	Max. digging reach	11100 mm	11100 mm
G	Max. digging reach at ground level	10920 mm	10920 mm
H	Max. swing radius	4430 mm	4430 mm
SAE Rating	Bucket digging force at power max	200 kN 20400 kg	200 kN 20400 kg
	Arm crowd force at power max	165 kN 16800 kg	165 kN 16800 kg
ISO Rating	Bucket digging force at power max	228 kN 23200 kg	228 kN 23200 kg
	Arm crowd force at power max	171 kN 17400 kg	171 kN 17400 kg

Working range data applicable for machines when fitted with 3185 mm arm and 1.4m³ SAE heaped factory bucket.

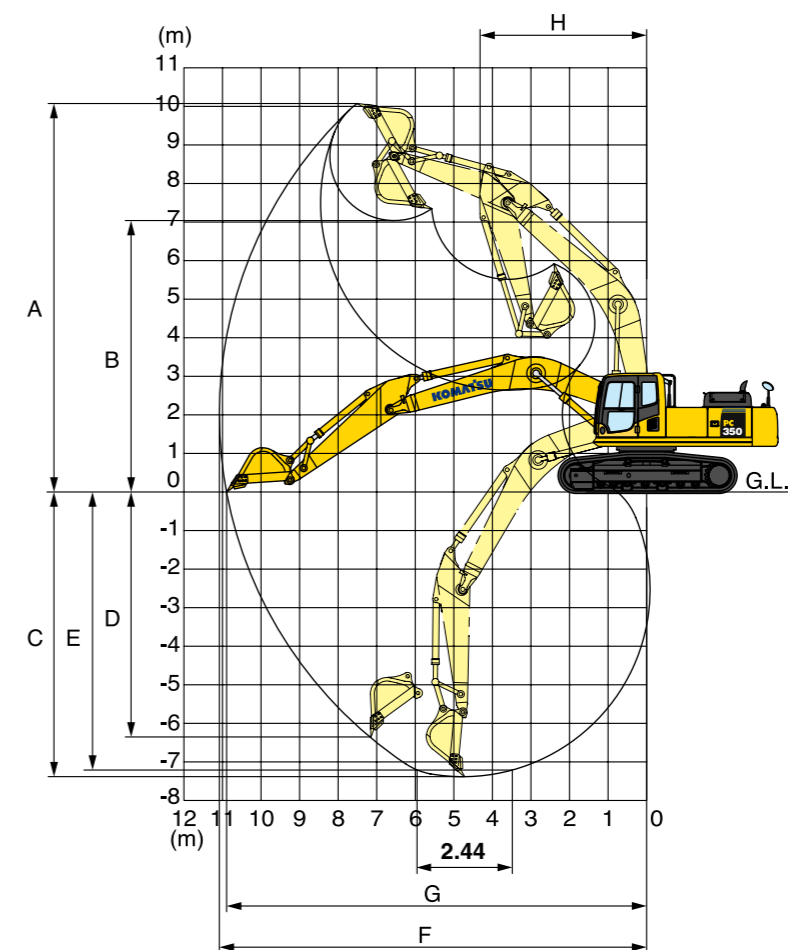



LIFTING CAPACITY WITH LIFTING MODE

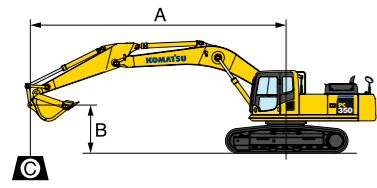

- A: Reach from swing center
- B: Bucket hook height
- C: Lifting capacity
- Cf: Rating over front
- Cs: Rating over side
- ☉: Rating at maximum reach

PC300-8M0 Boom: 6470 mm Arm: 3185 mm Shoes: 600 mm triple grouser Bucket: 1.4 m3 SAE heaped (1015 kg)												
A \ B	☉ MAX		9.1 m		7.6 m		6.1 m		4.6 m		3 m	
	Cf	Cs	Cf	Cs	Cf	Cs	Cf	Cs	Cf	Cs	Cf	Cs
6.1 m	*5250 kg	4400 kg			*7150 kg	5700 kg						
4.6 m	*5400 kg	3750 kg	5700 kg	3850 kg	*7600 kg	5500 kg	*9000 kg	8150 kg				
3.0 m	5150 kg	3450 kg	5550 kg	3750 kg	7650 kg	5200 kg	*10250 kg	7600 kg	*14250 kg	12050 kg		
1.5 m	5000 kg	3300 kg	5400 kg	3600 kg	7300 kg	4950 kg	10550 kg	7100 kg	*16550 kg	10950 kg		
0 m	5100 kg	3350 kg	5300 kg	3500 kg	7100 kg	4700 kg	10150 kg	6700 kg	16300 kg	10400 kg		
-1.5 m	5450 kg	3600 kg	5250 kg	3450 kg	6950 kg	4600 kg	9900 kg	6550 kg	16100 kg	10250 kg	*9800 kg	*9800 kg
-3.0 m	6350 kg	4200 kg			7000 kg	4600 kg	9900 kg	6500 kg	*15050 kg	10350 kg	*18100 kg	*18100 kg
-4.5 m	*7400 kg	5500 kg					*9300 kg	6700 kg	*12350 kg	10650 kg	*16000 kg	*16000 kg
-6.1 m									*7450 kg	*7450 kg		

PC300LC-8M0 Boom: 6470 mm Arm: 3185 mm Shoes: 600 mm triple grouser Bucket: 1.4 m3 SAE heaped (1015 kg)												
A \ B	☉ MAX		9.1 m		7.6 m		6.1 m		4.6 m		3 m	
	Cf	Cs	Cf	Cs	Cf	Cs	Cf	Cs	Cf	Cs	Cf	Cs
6.1 m	*5250 kg	4450 kg			*7150 kg	5800 kg						
4.6 m	*5400 kg	3850 kg	6500 kg	3950 kg	*7600 kg	5600 kg	*9000 kg	8250 kg				
3.0 m	*5700 kg	3500 kg	6350 kg	3800 kg	*8400 kg	5300 kg	*10250 kg	7700 kg	*14250 kg	12200 kg		
1.5 m	5700 kg	3350 kg	6200 kg	3650 kg	8350 kg	5050 kg	*11550 kg	7200 kg	*16550 kg	11150 kg		
0 m	5850 kg	3400 kg	6050 kg	3550 kg	8150 kg	4800 kg	11650 kg	6850 kg	*17000 kg	10600 kg		
-1.5 m	6300 kg	3650 kg	6000 kg	3500 kg	8000 kg	4700 kg	11450 kg	6650 kg	*16550 kg	10450 kg	*9800 kg	*9800 kg
-3.0 m	7250 kg	4250 kg			8000 kg	4700 kg	*11300 kg	6650 kg	*15050 kg	10550 kg	*18100 kg	*18100 kg
-4.5 m	*7400 kg	5600 kg					*9300 kg	6800 kg	*12350 kg	10850 kg	*16000 kg	*16000 kg
-6.1 m									*7450 kg	*7450 kg		

PC350LC-8M0 Boom: 6470 mm Arm: 3185 mm Shoes: 600 mm triple grouser Bucket: 1.4 m3 SAE heaped (1015 kg)												
A \ B	☉ MAX		9.1 m		7.6 m		6.1 m		4.6 m		3 m	
	Cf	Cs	Cf	Cs	Cf	Cs	Cf	Cs	Cf	Cs	Cf	Cs
6.1 m	*5250 kg	4900 kg			*7150 kg	6350 kg						
4.6 m	*5400 kg	4250 kg	*6500 kg	4350 kg	*7600 kg	6100 kg	*9000 kg	8950 kg				
3.0 m	*5750 kg	3900 kg	6650 kg	4200 kg	*8400 kg	5850 kg	*10250 kg	8400 kg	*14250 kg	13350 kg		
1.5 m	6000 kg	3750 kg	6500 kg	4050 kg	8750 kg	5550 kg	*11550 kg	7900 kg	*16550 kg	12300 kg		
0 m	6100 kg	3800 kg	6350 kg	3950 kg	8500 kg	5350 kg	12150 kg	7550 kg	*17000 kg	11750 kg		
-1.5 m	6600 kg	4100 kg	6300 kg	3900 kg	8350 kg	5200 kg	11950 kg	7350 kg	*16500 kg	11600 kg	*9800 kg	*9800 kg
-3.0 m	*7550 kg	4800 kg			8400 kg	5250 kg	*11300 kg	7350 kg	*15050 kg	11700 kg	*18100 kg	*18100 kg
-4.5 m	*7400 kg	6300 kg					*9300 kg	7550 kg	*12350 kg	11900 kg	*16000 kg	*16000 kg
-6.1 m									*7450 kg	*7450 kg		

*Load is limited by hydraulic capacity rather than tipping. Ratings are based on SAE standard No. J1097. Rated loads do not exceed 87% of hydraulic lift capacity or 75% of tipping load.



STANDARD EQUIPMENT

ENGINE:

- Additional filter system for poor-quality fuel (water separator)
- Air pre-cleaner
- Automatic engine warm-up system
- Dry type air cleaner, double element
- Engine, Komatsu SAA6D114E-3
- Engine overheat prevention system
- Large capacity fuel pre-filter
- Radiator and oil cooler dust proof net
- Side by side coolers
- Suction cooling fan

ELECTRICAL SYSTEM:

- Auto-decel
- Alternator, 24V / 60A
- Batteries, 2 X 12 V / 120Ah
- Battery isolation, single pole lockable
- Emergency stops x 3
- Starting motor, 24V / 11kW
- Voltage reducer 24V to 12V, with socket
- Working lights
 - 1 x boom
 - 1 x RH
 - 3 x cab
 - 1 x counterweight

HYDRAULIC SYSTEM:

- Arm holding valve
- Boom holding valve
- Boom and arm burst valve protection
- Dual flow hammer piping
- Full flow in-line filter
- "HydrauMind" closed centre load sensing system
- Overload alarm
- Power maximizing system
- PPC hydraulic control system
- Quick hitch piping with safety switch and alarm
- Two-mode settings for boom
- Working mode selection system

GUARDS AND COVERS:

- Bump rails
- Engine side covers, perforated
- Fan guard structure
- Revolving frame under cover

UNDERCARRIAGE:

- 600 mm triple grouser shoes
- Hydraulic track adjusters (each side)
- Track frame undercover
- Track guiding guard, centre section:
 - PC300-8M0 & PC300LC-8M0
- Track roller guards (full length):
 - PC350LC-8M0
- Track roller:
 - PC300-8M0, 7 each side
 - PC300LC-8M0, 8 each side
 - PC350LC-8M0, 8 each side

OPERATOR ENVIRONMENT:

- AM / FM radio
- Bolt-on top guard
- [Operator Protective Guard level 2 (OPG)]
- Half height cab front guard
- EMMS monitoring system
- Large capacity automatic air conditioner
- Multi-function color monitor
- Rear view mirror (RH, LH, sidewise)
- ROPS cab (ISO 12117-2 and OPG Level 1) with vandal cover provision
- Rotating beacon with guard
- Seat belt, retractable
- Seat, suspension

OTHER EQUIPMENT:

- Counterweight
- Electric horn
- Handrails, full deck with kick plate
- Level indicator
- Rear reflector
- Travel alarm
- Slip-resistant plates



OPTIONAL FACTORY EQUIPMENT

UNDERCARRIAGE:

- 700 mm triple grouser shoes
- 800 mm triple grouser shoes
- Track roller guards (full length)
 - PC300-8M0 & PC300LC-8M0

WORK EQUIPMENT:

- Arms
 - 2550 mm arm assembly
 - 4020 mm arm assembly

OPERATOR ENVIRONMENT:

- Full height cab front guard
- [Operator Protective Guard level 2 (OPG)]

